

Features

- Slew rate 500 V/ μ s
- ± 33 mA output current
- Drives $\pm 2.4V$ into 75 Ω
- Differential phase $< 0.1^\circ$
- Differential gain $< 0.1\%$
- V supply $\pm 5V$ to $\pm 18V$
- Output short circuit protected
- Uses current mode feedback
- 1% settling time of 50 ns for 10V step
- Low cost
- 9 mA supply current
- 8-pin mini-dip

Applications

- Video gain block
- Residue amplifier
- Radar systems
- Current to voltage converter
- Coax cable driver with gain of 2

Ordering Information

Part No.	Temp. Range	Pkg.	Outline #
EL2020CN	-40°C to +85°C	P-DIP	MDP0031
EL2020CM	-40°C to +85°C	20-Lead	MDP0027
		SOL	

General Description

The EL2020 is a fast settling, wide bandwidth amplifier optimized for gains between -10 and +10. Built using the Elantec monolithic Complementary Bipolar process, this amplifier uses current mode feedback to achieve more bandwidth at a given gain than a conventional voltage feedback operational amplifier.

The EL2020 will drive two double terminated 75 Ω coax cables to video levels with low distortion. Since it is a closed loop device, the EL2020 provides better gain accuracy and lower distortion than an open loop buffer. The device includes output short circuit protection, and input offset adjust capability.

The bandwidth and slew rate of the EL2020 are relatively independent of the closed loop gain taken. The 50 MHz bandwidth at unity gain only reduces to 30 MHz at a gain of 10. The EL2020 may be used in most applications where a conventional op amp is used, with a big improvement in speed power product.

Elantec products and facilities comply with Elantec document, QRA-1: *Processing-Monolithic Products.*

Connection Diagrams

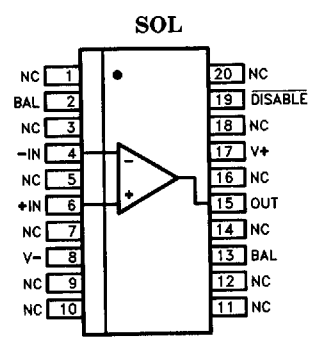

2020-2

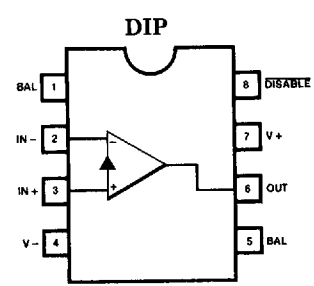

2020-1

Manufactured under U.S. Patent No. 4,893,091.

EL2020C

50 MHz Current Feedback Amplifier

EL2020C

Absolute Maximum Ratings (25°C)

V_S	Supply Voltage	$\pm 18V$ or $36V$	T_A	Operating Temperature Range	$-40^\circ C$ to $+85^\circ C$
V_{IN}	Input Voltage	$\pm 15V$ or V_S	T_J	Operating Junction Temperature	
ΔV_{IN}	Differential Input Voltage	$\pm 10V$		Plastic Package, SOL	$150^\circ C$
I_{IN}	Input Current (Pins 2 or 3)	± 10 mA	T_{ST}	Storage Temperature	$-65^\circ C$ to $+150^\circ C$
I_{INS}	Input Current (Pins 1, 5, or 8)	± 5 mA			
P_D	Maximum Power Dissipation				
	(See Curves)	$1.25W$			
I_{OP}	Peak Output Current	Short Circuit			
		Protected			
	Output Short Circuit Duration				
	(Note 2)	Continuous			

Important Note:

All parameters having Min/Max specifications are guaranteed. The Test Level column indicates the specific device testing actually performed during production and Quality Inspection. Elantec performs most electrical tests using modern high-speed automatic test equipment, specifically the LTX77 Series system. Unless otherwise noted, all tests are pulsed tests, therefore $T_J = T_C = T_A$.

Test Level	Test Procedure
I	100% production tested and QA sample tested per QA test plan QCX0002.
II	100% production tested at $T_A = 25^\circ C$ and QA sample tested at $T_A = 25^\circ C$, T_{MAX} and T_{MIN} per QA test plan QCX0002.
III	QA sample tested per QA test plan QCX0002.
IV	Parameter is guaranteed (but not tested) by Design and Characterization Data.
V	Parameter is typical value at $T_A = 25^\circ C$ for information purposes only.

Open Loop Characteristics $V_S = \pm 15V$

Parameter	Description	Temp	Limits			Test Level	Units
			Min	Typ	Max		
V_{OS} (Note 1)	Input Offset Voltage	$25^\circ C$	-10	3	+10	I	mV
		T_{MIN}, T_{MAX}	-15		+15	III	mV
$\Delta V_{OS}/\Delta T$	Offset Voltage Drift			-30		V	$\mu V/^\circ C$
CMRR (Note 3)	Common Mode Rejection Ratio	ALL	50	60		II	dB
PSRR (Note 4)	Power Supply Rejection Ratio	$25^\circ C$	65	75		I	dB
		T_{MIN}, T_{MAX}	60			III	dB
$+I_{IN}$	Non-inverting Input Current	$25^\circ C, T_{MAX}$	-15	5	+15	II	μA
		T_{MIN}	-25		+25	III	μA
$+R_{IN}$	Non-Inverting Input Resistance	ALL	1	5		II	M Ω
$+IPSR$ (Note 4)	Non-Inverting Input Current Power Supply Rejection	$25^\circ C, T_{MAX}$		0.05	0.5	II	$\mu A/V$
		T_{MIN}			1.0	III	$\mu A/V$
$-I_{IN}$ (Note 1)	- Input Current	$25^\circ C, T_{MAX}$	-40	10	+40	II	μA
		T_{MIN}	-50		+50	III	μA

3129557 0004406 918

2

EL2020C

50 MHz Current Feedback Amplifier

Open Loop Characteristics $V_S = \pm 15V$ — Contd.

Parameter	Description	Temp	Limits			Test Level	Units
			Min	Typ	Max		
-ICMR (Note 3)	- Input Current Common Mode Rejection	25°C, T _{MAX}		0.5	2.0	II	μA/V
		T _{MIN}			4.0	III	μA/V
-IPSR (Note 4)	- Input Current Power Supply Rejection	25°C, T _{MAX}		0.05	0.5	II	μA/V
		T _{MIN}			1.0	III	μA/V
R _{o1}	Transimpedance ($\Delta V_{OUT}/\Delta(-I_{IN})$) R _L = 400Ω, V _{OUT} = ±10V	25°C, T _{MAX}	300	1000		II	V/mA
		T _{MIN}	50			III	V/mA
A _{VOL1}	Open Loop DC Voltage Gain R _L = 400Ω, V _{OUT} = ±10V	25°C, T _{MAX}	70	80		II	dB
		T _{MIN}	60			III	dB
A _{VOL2}	Open Loop DC Voltage Gain R _L = 100Ω, V _{OUT} = ±2.5V	25°C, T _{MAX}	60	70		II	dB
		T _{MIN}	55			III	dB
V _O	Output Voltage Swing R _L = 400Ω	25°C, T _{MAX}	±12	±13		II	V
		T _{MIN}	±11			III	V
I _{OUT}	Output Current R _L = 400Ω	25°C, T _{MAX}	±30	±32.5		II	mA
		T _{MIN}	±27.5			III	mA
I _s	Quiescent Supply Current	25°C		9	12	I	mA
		T _{MIN} , T _{MAX}			15	III	mA
I _{s off}	Supply Current, Disabled, V _g = 0V	ALL		5.5	7.5	II	mA
I _{logic}	Pin 8 Current, Pin 8 = 0V	ALL		1.1	1.5	II	mA
I _D	Min Pin 8 Current to Disable	ALL		120	250	II	μA
I _e	Max Pin 8 Current to Enable	ALL			30	II	μA

■ 3129557 0004407 854 ■

EL2020C

50 MHz Current Feedback Amplifier

EL2020C

AC Closed Loop Characteristics EL2020C $V_S = \pm 15V, T_A = 25^\circ C$

Parameter	Description	Min	Typ	Max	Test Level	Units
SR1	Closed Loop Gain of 1 V/V (0 dB), $R_F = 1 k\Omega$				I	
FPBW1	Slew Rate, $R_I = 400\Omega, V_O = \pm 10V$, test at $V_O = \pm 5V$	300	500		I	V/ μs
t_r1	Full Power Bandwidth (Note 5)	4.77	7.95		V	MHz
t_f1	Rise Time, $R_I = 100\Omega, V_{OUT} = 1V$, 10% to 90%		6		V	ns
t_p1	Fall Time, $R_I = 100\Omega, V_{OUT} = 1V$, 10% to 90%		6		V	ns
	Propagation Delay, $R_I = 100\Omega, V_{OUT} = 1V$, 50% Points		8		V	ns
BW	Closed Loop Gain of 1 V/V (0 dB), $R_F = 820\Omega$				V	MHz
t_s	-3 dB Small Signal Bandwidth, $R_I = 100\Omega, V_O = 100 mV$		50		V	ns
	1% Settling Time, $R_I = 400\Omega, V_O = 10V$		50		V	ns
	0.1% Settling Time, $R_I = 400\Omega, V_O = 10V$		90		V	ns
SR10	Closed Loop Gain of 10 V/V (20 dB), $R_F = 1 k\Omega, R_G = 111\Omega$				I	
FPBW10	Slew Rate, $R_I = 400\Omega, V_O = \pm 10V$, Test at $V_O = \pm 5V$	300	500		I	V/ μs
t_r10	Full Power Bandwidth (Note 5)	4.77	7.95		V	MHz
t_f10	Rise Time, $R_I = 100\Omega, V_{OUT} = 1V$, 10% to 90%		25		V	ns
t_p10	Fall Time, $R_I = 100\Omega, V_{OUT} = 1V$, 10% to 90%		25		V	ns
	Propagation Delay, $R_I = 100\Omega, V_{OUT} = 1V$, 50% points		12		V	ns
BW	Closed Loop Gain of 10 V/V (20 dB), $R_F = 680\Omega, R_G = 76\Omega$				V	MHz
t_s	-3 dB Small Signal Bandwidth, $R_I = 100\Omega, V_O = 100 mV$		30		V	ns
	1% Settling Time, $R_I = 400 \Omega, V_O = 10V$		55		V	ns
	0.1% Settling Time, $R_I = 400\Omega, V_O = 10V$		280		V	ns

Note 1: The offset voltage and inverting input current can be adjusted with an external 10 k Ω pot between pins 1 and 5 with the wiper connected to V_{CC} (Pin 7) to make the output offset voltage zero.

Note 2: A heat sink is required to keep the junction temperature below the absolute maximum when the output is short circuited.

Note 3: $V_{CM} = \pm 10V$.

Note 4: $\pm 4.5V \leq V_S \leq \pm 18V$.

Note 5: Full Power Bandwidth is guaranteed based on Slew Rate measurement. $FPBW = SR/2\pi V_{peak}$.

3129557 0004408 790

2

EL2020C

50 MHz Current Feedback Amplifier

Typical Performance Curves Non-Inverting Gain of One

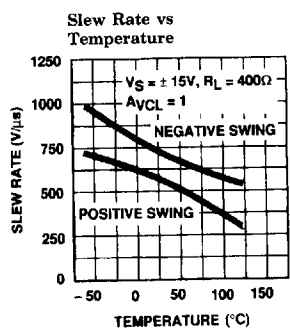
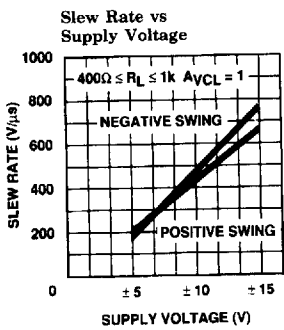
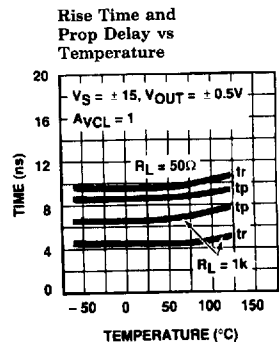
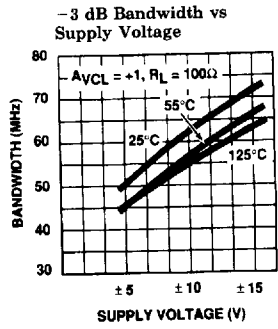
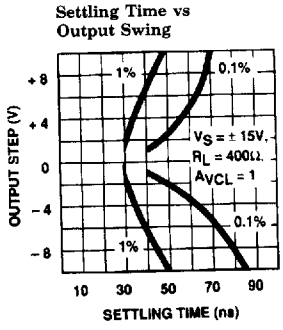
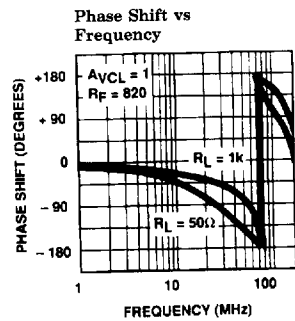
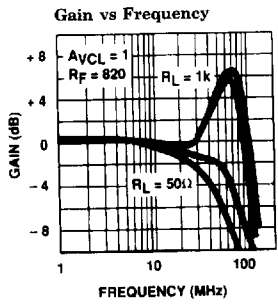
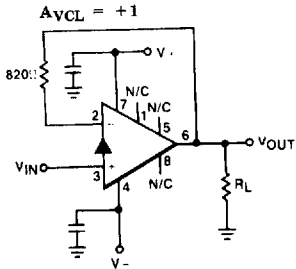

3129557 0004409 627

EL2020C

50 MHz Current Feedback Amplifier

EL2020C

Typical Performance Curves — Contd. Inverting Gain of One

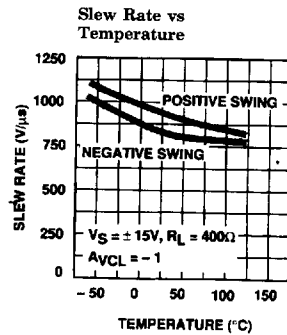
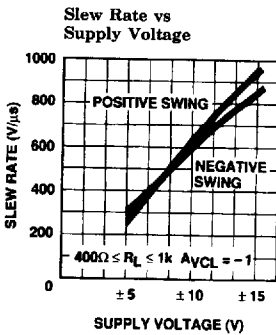
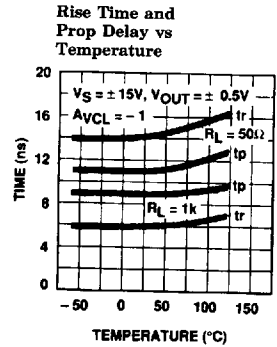
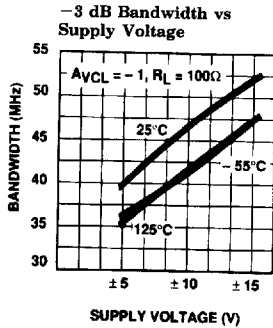
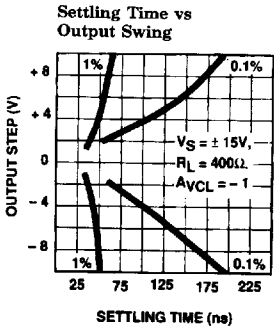
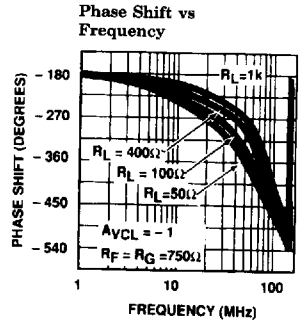
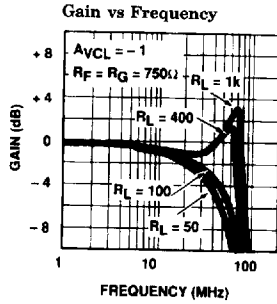
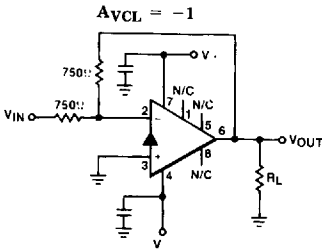

3129557 0004410 349

2

EL2020C

50 MHz Current Feedback Amplifier

Typical Performance Curves — Contd. Non-Inverting Gain of Two

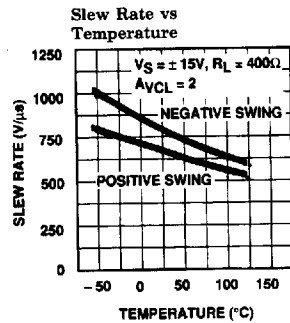
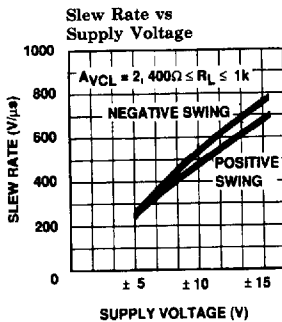
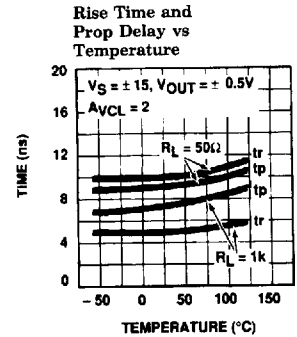
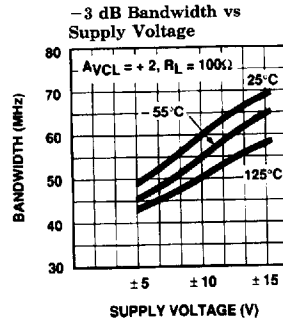
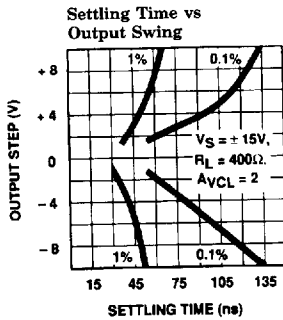
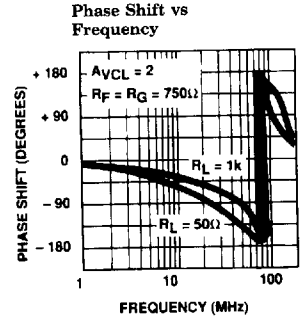
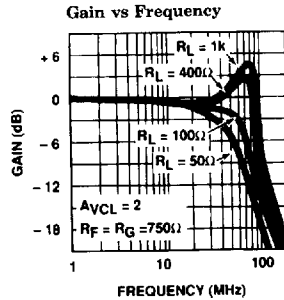
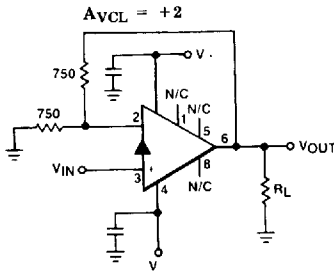

3129557 0004411 285

EL2020C

50 MHz Current Feedback Amplifier

EL2020C

Typical Performance Curves — Contd. Non-Inverting Gain of Ten

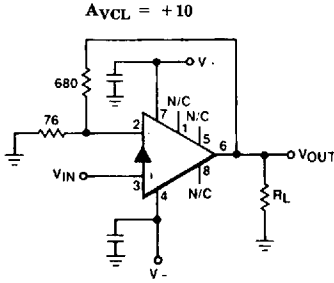

Gain vs Frequency

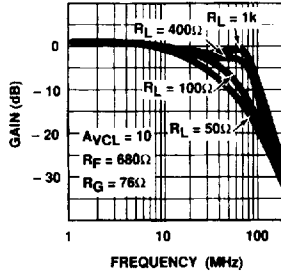

Phase Shift vs Frequency

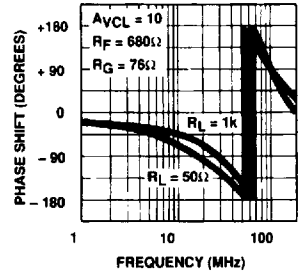

Settling Time vs Output Swing

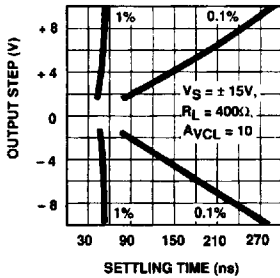

-3 dB Bandwidth vs Supply Voltage

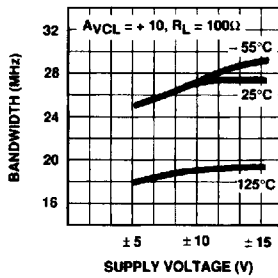

Rise Time and Prop Delay vs Temperature

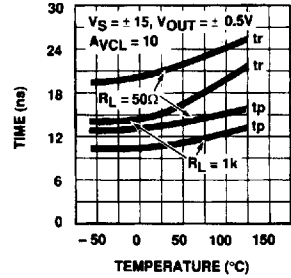

Slew Rate vs Supply Voltage

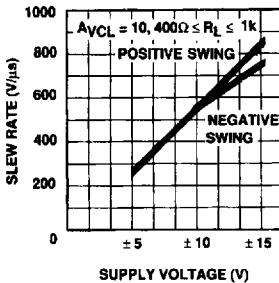

Slew Rate vs Temperature

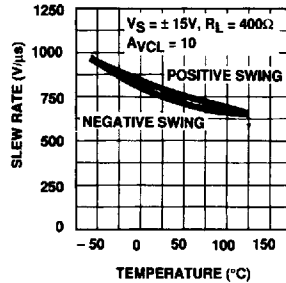

2020-7

3129557 0004412 111

EL2020C

50 MHz Current Feedback Amplifier

Typical Performance Curves — Contd.

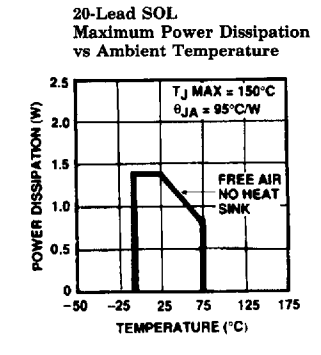
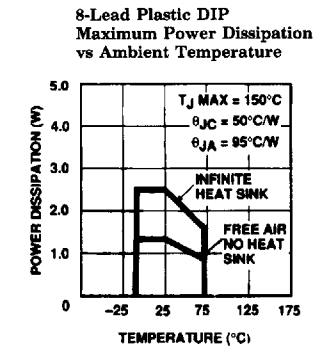
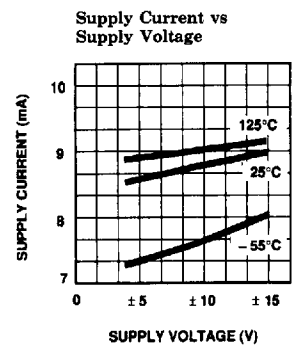
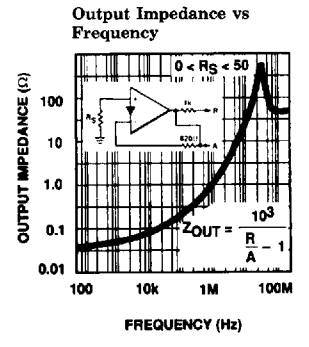
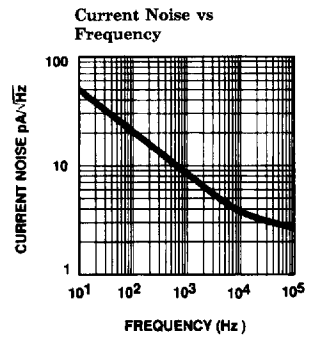
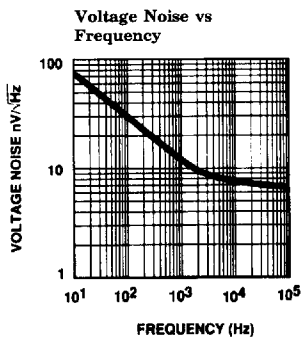
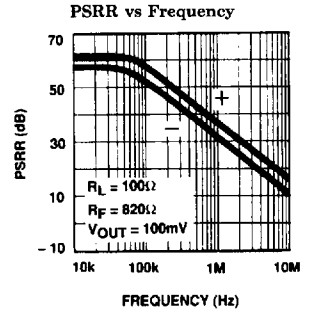
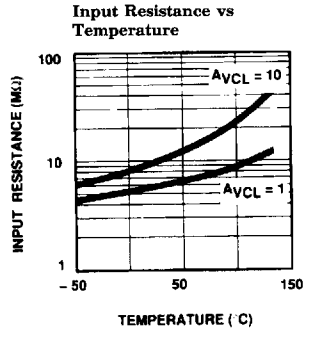
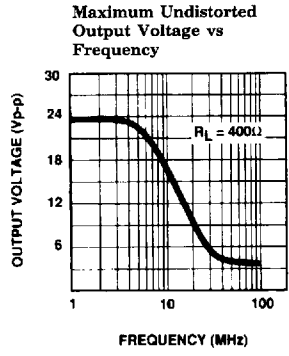

3129557 0004413 058

EL2020C

50 MHz Current Feedback Amplifier

EL2020C

Application Information

Theory of Operation

The EL2020 has a unity gain buffer similar to the EL2003 from the non-inverting input to the inverting input. The error signal of the EL2020 is a current flowing into (or out of) the inverting input. A very small change in current flowing through the inverting input will cause a large change in the output voltage. This current amplification is the transresistance (R_{OL}) of the EL2020 [$V_{OUT} = R_{OL} * I_{INV}$]. Since R_{OL} is very large ($\approx 10^6$), the current flowing into the inverting input in the steady state (non-slewing) condition is very small.

Therefore we can still use op-amp assumptions as a first order approximation for circuit analysis, namely that...

1. The voltage across the inputs ≈ 0 and
2. The current into the inputs is ≈ 0

Simplified Block Diagram of EL2020

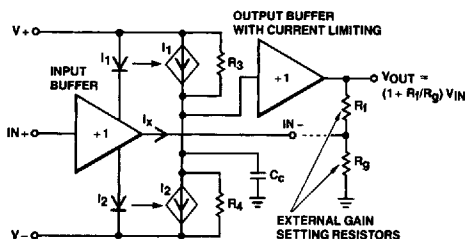

2020-10

Resistor Value Selection and Optimization

The value of the feedback resistor (and an internal capacitor) sets the AC dynamics of the EL2020. A nominal value for the feedback resistor is 1 k Ω , which is the value used for production testing. This value guarantees stability. For a given gain, the bandwidth may be increased by decreasing the feedback resistor and, conversely, the bandwidth will be decreased by increasing the feedback resistor.

Reducing the feedback resistor too much will result in overshoot and ringing, and eventually oscillations. Increasing the feedback resistor results

in a lower -3 dB frequency. Attenuation at high frequency is limited by a zero in the closed loop transfer function which results from stray capacitance between the inverting input and ground.

Power Supplies

The EL2020 may be operated with single or split power supplies as low as $\pm 3V$ (6V total) to as high as $\pm 18V$ (36V total). The slew rate degrades significantly for supply voltages less than $\pm 5V$ (10V total), but the bandwidth only changes 25% for supplies from $\pm 3V$ to $\pm 18V$. It is not necessary to use equal value split power supplies, i.e., -5V and +12V would be excellent for 0V to 1V video signals. Bypass capacitors from each supply pin to a ground plane are recommended. The EL2020 will not oscillate even with minimal bypassing, however, the supply will ring excessively with inadequate capacitance. To eliminate supply ringing and the errors it might cause, a 4.7 μF tantalum capacitor with short leads is recommended for both supplies. Inadequate supply bypassing can also result in lower slew rate and longer settling times.

Non-Inverting Amplifier

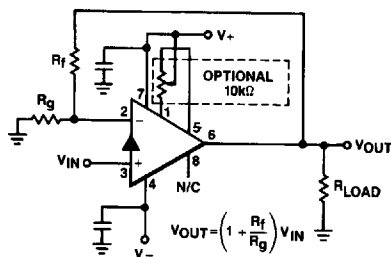

2020-11

EL2020 Typical Non-Inverting Amplifier Characteristics

A _v	R _F	R _G	Bandwidth	10V Settling Time	
				1%	0.1%
+1	820 Ω	None	50 MHz	50 ns	90 ns
+2	750 Ω	750 Ω	50 MHz	50 ns	100 ns
+5	680 Ω	170 Ω	50 MHz	50 ns	200 ns
+10	680 Ω	76 Ω	30 MHz	55 ns	280 ns

3129557 0004414 T94

EL2020C

50 MHz Current Feedback Amplifier

Application Information — Contd.

Summing Amplifier

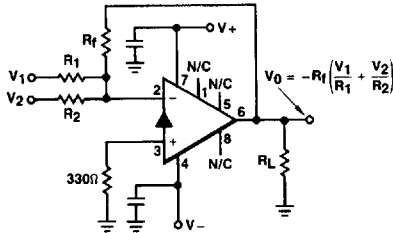

2020-12

EL2020 Typical Inverting Amplifier Characteristics

A _v	R _F	R ₁ , R ₂	Bandwidth	10V Settling Time	
				1%	0.1%
-1	750Ω	750Ω	40 MHz	50 ns	130 ns
-2	750Ω	375Ω	40 MHz	55 ns	160 ns
-5	680Ω	130Ω	40 MHz	55 ns	160 ns
-10	680Ω	68Ω	30 MHz	70 ns	170 ns

Input Range

The non-inverting input to the EL2020 looks like a high resistance in parallel with a few picofarads in addition to a DC bias current. The input characteristics change very little with output loading, even when the amplifier is in current limit.

The input characteristics also change when the input voltage exceeds either supply by 0.5V. This happens because the input transistor's base-collector junctions forward bias. If the input exceeds the supply by LESS than 0.5V and then returns to the normal input range, the output will recover in less than 10 ns. However if the input exceeds the supply by MORE than 0.5V, the recovery time can be 100's of nanoseconds. For this reason it is recommended that Schottky diode clamps from input to supply be used if a fast recovery from large input overloads is required.

Source Impedance

The EL2020 is fairly tolerant of variations in source impedances. Capacitive sources cause no problems at all, resistive sources up to 100 kΩ present no problems as long as care is used in board layout to minimize output to input cou-

pling. Inductive sources may cause oscillations; a 1 kΩ resistor in series with the input lead will usually eliminate problems without sacrificing too much speed.

Current Limit

The EL2020 has internal current limits that protect the output transistors. The current limit goes down with junction temperature rise. At a junction temperature of +175°C the current limits are at about 50 mA. If the EL2020 output is shorted to ground when operating on ±15V supplies, the power dissipation could be as great as 1.1W. A heat sink is required in order for the EL2020 to survive an indefinite short. Recovery time to come out of current limit is about 50 ns.

Using the 2020 with Output Buffers

When more output current is required, a wide-band buffer amplifier can be included in the feedback loop of the EL2020. With the EL2003 the subsystem overshoots about 10% due to the phase lag of the EL2003. With the EL2004 in the loop, the overshoot is less than 2%. For even more output current, several buffers can be paralleled.

EL2020 Buffered with an EL2004

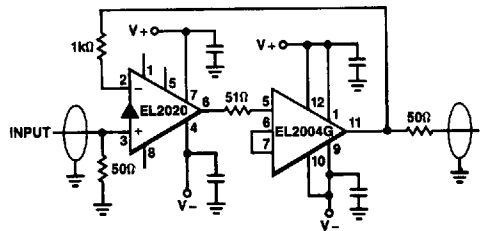

2020-13

Capacitive Loads

The EL2020 is like most high speed feedback amplifiers in that it does not like capacitive loads between 50 pF and 1000 pF. The output resistance works with the capacitive load to form a second non-dominant pole in the loop. This results in excessive peaking and overshoot and can lead to oscillations. Standard resistive isolation techniques used with other op amps work well to isolate capacitive loads from the EL2020.

EL2020C

50 MHz Current Feedback Amplifier

EL2020C

Application Information — Contd.

Offset Adjust

To calculate the amplifier system offset voltage from input to output we use the equation:

$$\text{Output Offset Voltage} = V_{OS} (R_F/R_G + 1) \pm I_{BIAS} (R_F)$$

The EL2020 output offset can be nulled by using a 10 k Ω potentiometer from pins 1 to 5 with the slider tied to pin 7 (+V_{CC}). This adjusts both the offset voltage and the inverting input bias current. The typical adjustment range is ± 80 mV at the output.

Compensation

The EL2020 is internally compensated to work with external feedback resistors for optimum bandwidth over a wide range of closed loop gain. The part is designed for a nominal 1 k Ω of feedback resistance, although it is possible to get more bandwidth by decreasing the feedback resistance.

The EL2020 becomes less stable by adding capacitance in parallel with the feedback resistor, so feedback capacitance is not recommended.

The EL2020 is also sensitive to stray capacitance from the inverting input to ground, so the board should be laid out to keep the physical size of this node small, with ground plane kept away from this node.

Active Filters

The EL2020's low phase lag at high frequencies makes it an excellent choice for high performance active filters. The filter response more closely approaches the theoretical response than with conventional op amps due to the EL2020's smaller propagation delay. Because the internal compensation of the EL2020 depends on resistive feedback, the EL2020 should be set up as a gain block.

Driving Cables

The EL2020 was designed with driving coaxial cables in mind. With 30 mA of output drive and low output impedance, driving one to three 75 Ω double terminated coax cables with one EL2020 is practical. Since it is easy to set up a gain of +2, the double matched method is the best way to drive coax cables, because the impedance match on both ends of the cable will suppress reflections. For a discussion on some of the other ways to drive cables, see the section on driving cables in the EL2003 data sheet.

Video Performance Characteristics

The EL2020 makes an excellent gain block for video systems, both RS-170 (NTSC) and faster. It is capable of driving 3 double terminated 75 Ω cables with distortion levels acceptable to broadcasters. A common video application is to drive a 75 Ω double terminated coax with a gain of 2.

To measure the video performance of the EL2020 in the non-inverting gain of 2 configuration, 5 identical gain-of-two circuits were cascaded (with a divide by two 75 Ω attenuator between each stage) to increase the errors.

The results, shown in the photos, indicate the entire system of 5 gain-of-two stages has a differential gain of 0.5% and a differential phase of 0.5°. This implies each device has a differential gain/phase of 0.1% and 0.1°, but these are too small to measure on single devices.

Differential Phase
of 5 Cascaded
Gain-Of-Two Stages

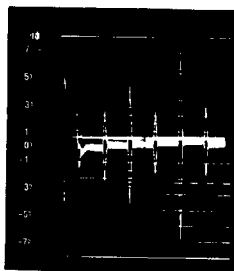

Differential Gain
of 5 Cascaded
Gain-Of-Two Stages

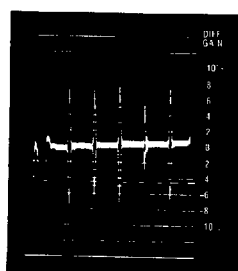

2020-14

3129557 0004416 867

2

EL2020C

50 MHz Current Feedback Amplifier

Application Information — Contd.

Video Distribution Amplifier

The distribution amplifier shown below features a difference input to reject common mode signals on the 75Ω coax cable input. Common mode rejection is often necessary to help to eliminate 60 Hz noise found in production environments.

Video Distribution Amplifier with Difference Input

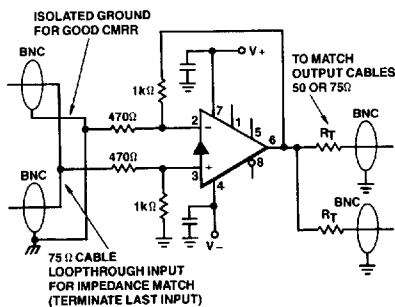

2020-15

EL2020 Disable/Enable Operation

The EL2020 has an enable/disable control input at pin 8. The device is enabled and operates normally when pin 8 is left open or returned to pin 7, V_{CC} . When more than 250 μA is pulled from pin 8, the EL2020 is disabled. The output becomes a high impedance, the inverting input is no longer driven to the positive input voltage, and the supply current is halved. To make it easy to use this feature, there is an internal resistor to limit the current to a safe level (~ 1.1 mA) if pin 8 is grounded.

To draw current out of pin 8 an "open collector output" logic gate or a discrete NPN transistor can be used. This logic interface method has the advantage of level shifting the logic signal from 5V supplies to whatever supply the EL2020 is operating on without any additional components.

Using the EL2020 as a Multiplexer

An interesting use of the enable feature is to combine several amplifiers in parallel with their outputs common. This combination then acts similar to a MUX in front of an amplifier. A typical circuit is shown.

When the EL2020 is disabled, the DC output impedance is very high, over 10 k Ω . However there is also an output capacitance that is non-linear. For signals of less than 5V peak to peak, the output capacitance looks like a simple 15 pF capacitor. However, for larger signals the output capacitance becomes much larger and non-linear.

The example multiplexer will switch between amplifiers in 5 μs for signals of less than $\pm 2V$ on the outputs. For full output signals of 20V peak to peak, the selection time becomes 25 μs . The disabled outputs also present a capacitive load and therefore only three amplifiers can have their outputs shorted together. However an unlimited number can sum together if a small resistor (25 Ω) is inserted in series with each output to isolate it from the "bus". There will be a small gain loss due to the resistors of course.

Using the EL2020 as a Multiplexer

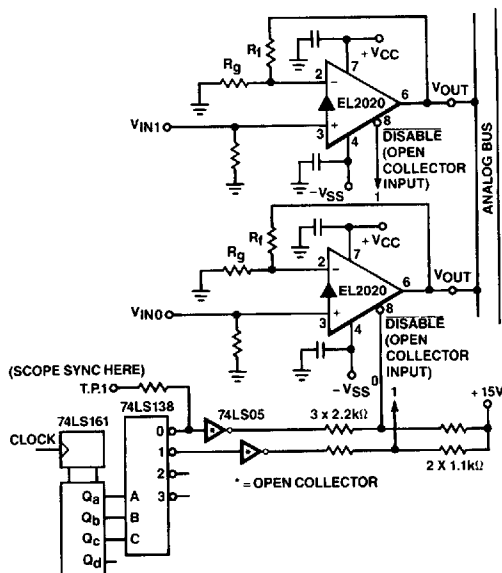

2020-16

3129557 0004417 7T3

EL2020C

50 MHz Current Feedback Amplifier

EL2020C

Burn-In Circuit

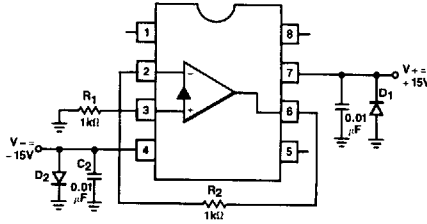

2020-17

Pin numbers are for DIP Packages.
All Packages Use the Same Schematic.

Equivalent Circuit

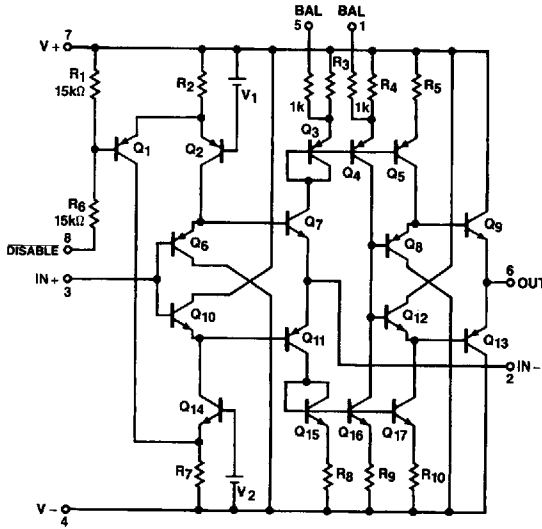

2020-16

3129557 0004418 63T

2

EL2020C

50 MHz Current Feedback Amplifier

EL2020C

EL2020 Macromodel — Contd.

```
ios1 7 19 2.5mA
ios2 20 4 2.5mA
*
* Supply
*
ips 7 4 3mA
*
* Error Terms
*
ivos 0 23 5mA
vxx 23 0 0V
e4 24 0 6 0 1.0
e5 25 0 7 0 1.0
e6 26 0 4 0 1.0
r9 24 23 1K
r10 25 23 1K
r11 26 23 1K
*
* Models
*
.model qn npn (is=5e-15 bf=100 tf=0.2nS)
.model qp pnp (is=5e-15 bf=100 tf=0.2nS)
.model dclamp d(is=1e-30 ibv=0.266 bv=1.67 n=4)
.ends
```

2

3129557 0004420 298

EL2020C

50 MHz Current Feedback Amplifier

EL2020 Macromodel

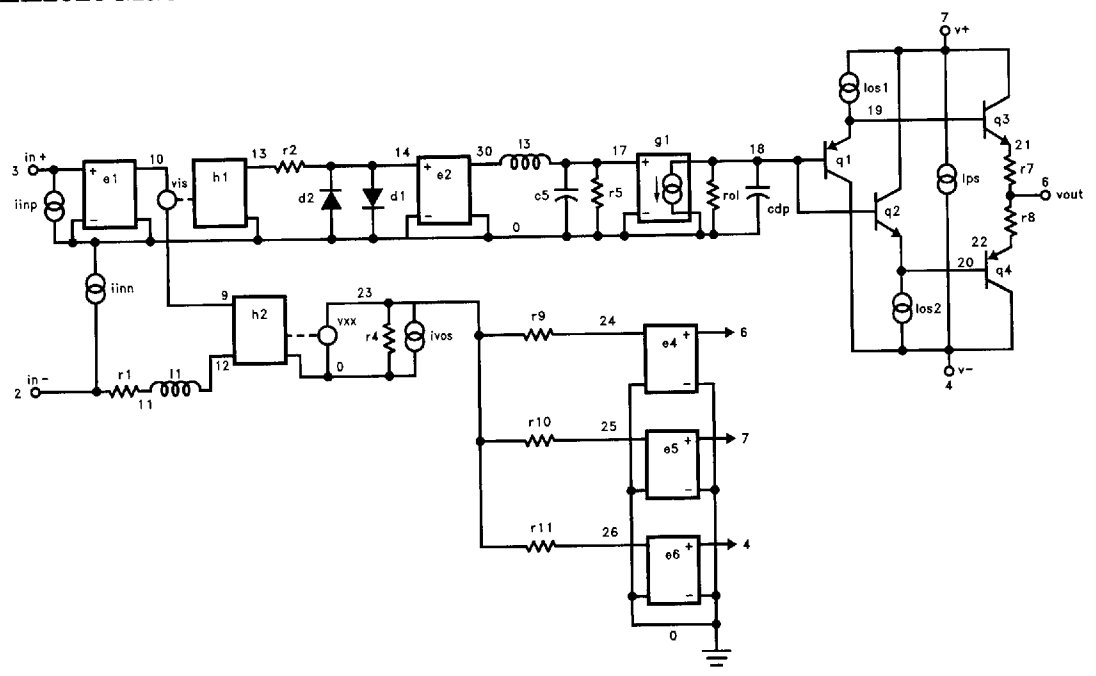

2020-22

3129557 0004421 124

Soldering Packages to PC Boards

DIP Packages

Wave soldering is recommended for DIP packages. Solder plated boards are recommended. Rosin mildly activated (RMA) flux is needed. Wave soldering using a dual wave system at $250^{\circ}\text{C} \pm 10^{\circ}\text{C}$ for two seconds per wave is preferable. Thorough cleaning of boards after soldering is required.

Hand soldering, Elantec's DIP packages will survive a peak temperature of 300°C (at leads) for a maximum period of 10 seconds.

Surface Mount Packages

Wave soldering and vapor phase or infrared (IR) reflow can be used for soldering surface mount packages to PC boards. Solder plated boards are recommended for wave soldering and vapor phase or IR reflow methods.

Wave Soldering: Adhesive is used to hold components on the boards during wave soldering. Place components on the board and cure adhesive

before wave soldering. Rosin mildly activated (RMA) flux or organic flux is needed. Wave soldering using a dual wave system at $250^{\circ}\text{C} \pm 10^{\circ}\text{C}$ for a maximum of two seconds per wave is preferable. Thorough cleaning of boards after soldering is required.

Reflow Soldering: Screen solder paste on board and attach components to board. Solder paste with RMA flux is recommended. Bake boards at 65°C – 90°C for 15 minutes. Preheat boards to within 60°C – 70°C of the solder temperature. To reflow solder paste with vapor phase method, the solder paste temperature must be maintained at or above 200°C for at least 30 seconds. The components temperature can not exceed 215°C . For the IR reflow method, the solder paste temperature must be maintained at or above 200°C for at least 30 seconds. The components temperature can not exceed 220°C . The temperature/time ramp-up during vapor phase or IR reflow shall be no greater than $2^{\circ}\text{C}/\text{sec}$.

Hand soldering, Elantec's surface mount packages will survive a peak temperature of 260°C (at leads) for a maximum period of 10 seconds.

Package Outlines

Rev. B

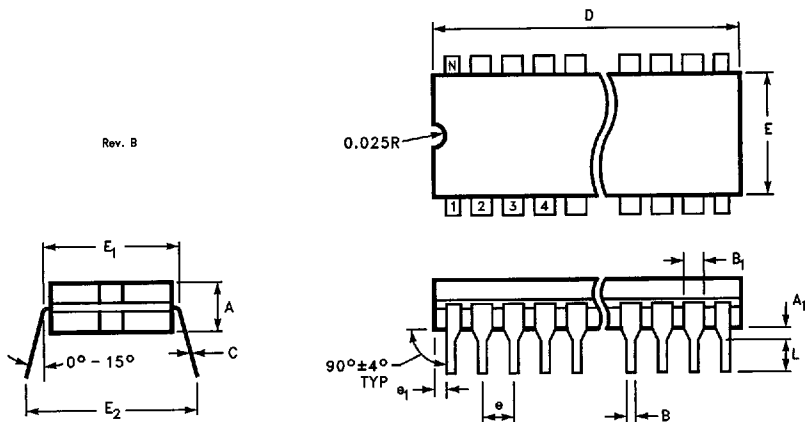

MDP0016 Rev. B

CerDIP Package

Lead Finish (Coml)—Tin Plate or Hot Solder DIP

Lead Finish (Mil)—Hot Solder DIP

Common Dimensions	Min	Max	Min	Max	Min	Max	Min	Max
A	0.140	0.160	0.140	0.160	0.140	0.160	0.140	0.160
A ₁	0.115	0.055	0.020	0.050	0.015	0.060	0.020	0.050
B	0.016	0.023	0.016	0.021	0.014	0.026	0.016	0.021
B ₁	0.050	0.065	0.050	0.060	0.038	0.068	0.050	0.060
C	0.008	0.012	0.008	0.012	0.008	0.018	0.008	0.012
D	0.375	0.395	0.760	0.785	0.940	0.960	1040.925	1.060
E	0.245	0.265	0.220	0.291	0.220	0.310	0.2780	0.298
E ₁	0.300	0.320	0.300	0.320	0.290	0.320	0.300	0.320
E ₂	0.340	0.390	0.340	0.390	0.360	0.410	0.340	0.390
e	0.090	0.110	0.090	0.110	0.090	0.110	0.090	0.110
e ₁	0.020	0.055	0.078	0.098	0.068	0.098	0.078	0.098
L	0.125	0.150	0.125	0.150	0.125	0.150	0.130	0.150
N	8-Lead		14-Lead		18-Lead		20-Lead	

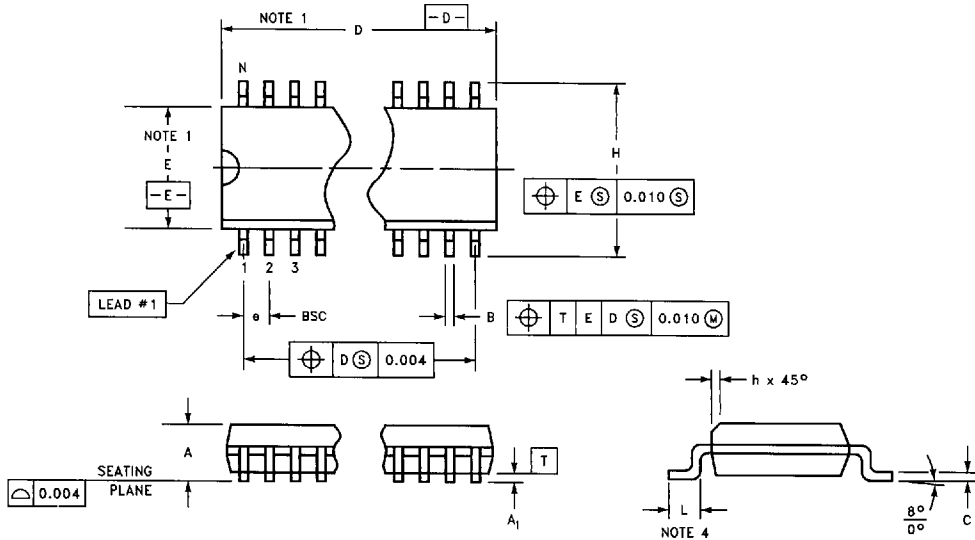

- NOTE 1: These dimensions do not include mold flash or protrusions. Mold flash protrusion shall not exceed .006" on any side.
 NOTE 2: SO-8, SO-14, SO-16 packages are narrow body (0.150").
 NOTE 3: Dimensions and tolerancing per ANSI Y14.5M-1982.
 NOTE 4: Flat area of lead foot.
 NOTE 5: SOL-24T2 (thermal package) has 2 fused leads on each side of package.
 NOTE 6: SOL-20T (thermal package) has 4 fused leads on each side of package.
 NOTE 7: SOL-28T contains a thermal metal slug.

REV. C

12

MDP0027 Rev. C
Package Outline—SOIC
 Lead Finish—Solder Plate

Symbol	Lead Count													
	SOL-28		SOL-20		SOL-16		SO-16		SO-14		SO-8		SOL-24	
	Min	Max	Min	Max	Min	Max	Min	Max	Min	Max	Min	Max	Min	Max
A	0.096	0.104	0.096	0.104	0.096	0.104	0.061	0.068	0.061	0.068	0.061	0.068	0.096	0.104
A ₁	0.004	0.011	0.004	0.011	0.004	0.011	0.004	0.010	0.004	0.010	0.004	0.010	0.004	0.011
B	0.014	0.019	0.014	0.019	0.014	0.019	0.014	0.019	0.014	0.019	0.014	0.019	0.014	0.019
C	0.009	0.012	0.009	0.012	0.009	0.012	0.008	0.010	0.008	0.010	0.008	0.010	0.009	0.012
D	0.696	0.712	0.498	0.510	0.397	0.430	0.386	0.394	0.337	0.344	0.189	0.196	0.598	0.614
E	0.291	0.299	0.291	0.299	0.291	0.299	0.150	0.157	0.150	0.157	0.150	0.157	0.291	0.299
e	0.050 BSC		0.050 BSC		0.050 BSC		0.050 BSC		0.050 BSC		0.050 BSC		0.050 BSC	
H	0.398	0.414	0.398	0.414	0.398	0.414	0.230	0.244	0.230	0.244	0.230	0.244	0.398	0.414
h	0.010	0.016	0.010	0.016	0.010	0.016	0.010	0.016	0.010	0.016	0.010	0.016	0.010	0.016
L	0.016	0.024	0.016	0.024	0.016	0.024	0.016	0.024	0.016	0.024	0.016	0.024	0.016	0.024

3129557 0005559 T20

Package Outlines

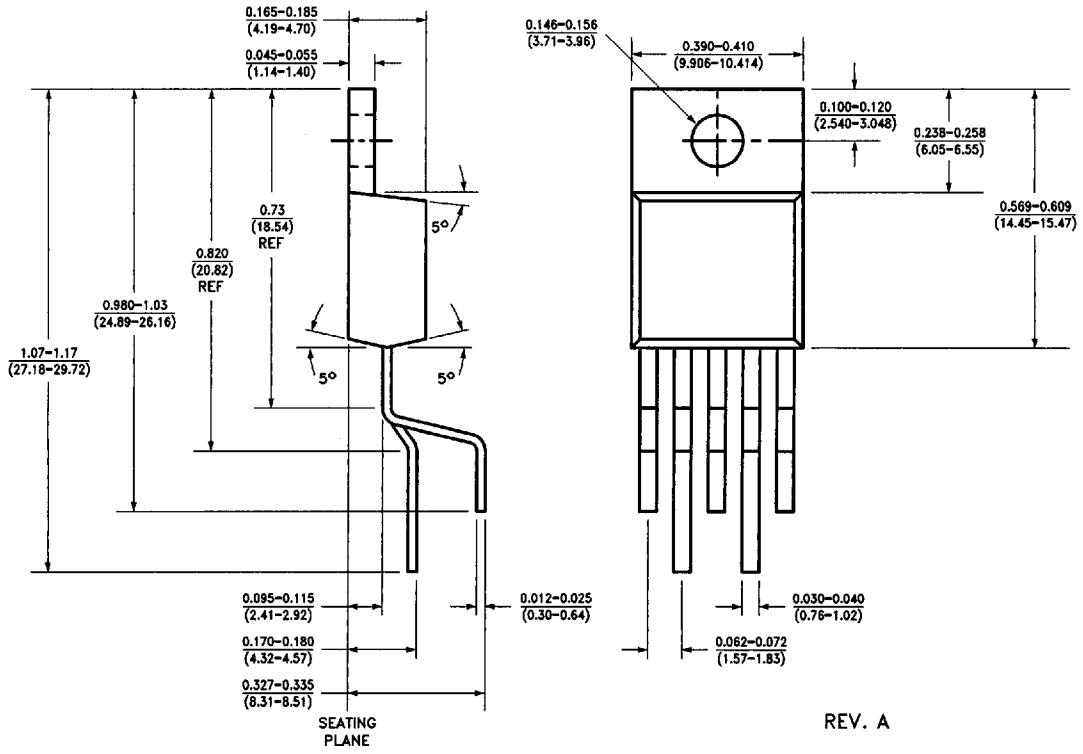

MDP0028 Rev. A
5-Lead TO-220
 Lead Finish—Solder Plate

REV. A

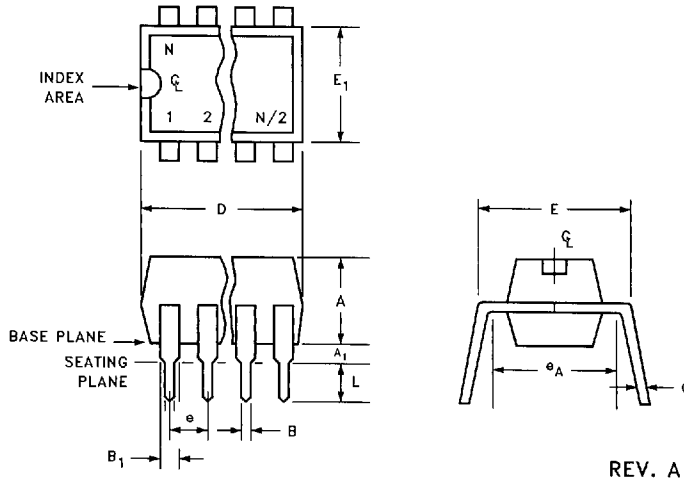

REV. A

MDP0031 Rev. A
Plastic Package
Lead Finish—Hot Solder DIP

Common Dimensions	Min	Max	Min	Max	Min	Max	Min	Max	Min	Max
A ₁	0.020	0.040	0.020	0.040	0.020	0.040	0.020	0.040	0.020	0.040
A	0.125	0.145	0.125	0.145	0.125	0.145	0.125	0.145	0.125	0.145
B	0.016	0.020	0.016	0.020	0.016	0.020	0.016	0.020	0.015	0.021
B ₁	0.050	0.070	0.050	0.070	0.050	0.070	0.050	0.070	0.050	0.070
C	0.008	0.012	0.008	0.012	0.008	0.012	0.008	0.012	0.008	0.012
D	0.350	0.385	0.745	0.755	0.745	0.755	0.875	0.905	0.925	1.045
E	0.295	0.320	0.295	0.320	0.295	0.320	0.295	0.320	0.295	0.320
E ₁	0.245	0.255	0.245	0.255	0.245	0.255	0.245	0.255	0.245	0.255
e	0.100 Typ		0.100 Typ		0.100 Typ		0.100 Typ		0.100 Typ	
e _A	0.300 Ref		0.300 Ref		0.300 Ref		0.300 Ref		0.300 Ref	
L	0.115	0.135	0.115	0.135	0.115	0.135	0.115	0.135	0.115	0.135
N	8		14		16		18		20	

Note: Package outline exclusive of any mold flashes. Mold flash protrusion shall not exceed 0.006" on any side.